

Varenummer: 209925V50M16

Beskrivelse: E+G Gevind indsats - GN 992.5-V50-M16

Mål

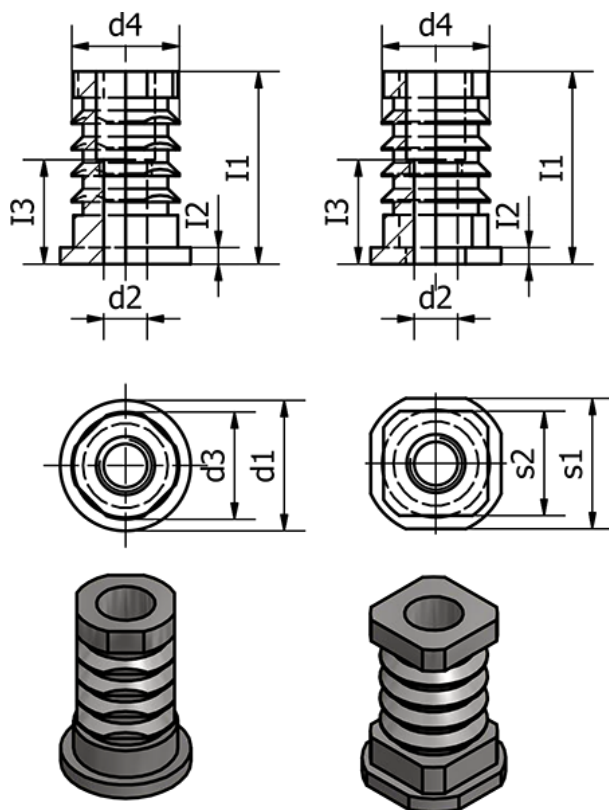

d1 =	s2 = 44
d2 = M16	Vægt (g) = 390
d3 =	
d4 = 44.5	
I1 = 37.5	
I2 = 2.5	
I3 = 30	
s1 = 50	